

LOAD DESIGN CHARTS



Note: Information deemed reliable at time of printing.
Please visit www.premiersips.com for latest information.
September 2020

www.premiersips.com



Table of Content

Premier SIP Structural Review	3
Premier SIPs R-value	4
Premier SIPs Weight	4
Splines	5
Load Design Chart #1a - Uniform Axial Loads - Type S Spline	6
Load Design Chart #1b - Uniform Axial Loads - Type L Spine	7
Load Design Chart #2a - Axial Point Loads	8
Load Design Chart #3a - Wall Uniform Transverse Loads	9
Load Design Chart #3b - Curtain Wall Uniform Transverse Loads	10
Load Design Chart #4a - Shear Loads - Seismic Design Categories A-C	11
Load Design Chart #4b - Shear Loads - Seismic Design Categories A-F	12
Load Design Chart #5a - Header: SIP Header Uniform Loads	13
Load Design Chart #5b - Header: Premier Insulated Header Beams Uniform Loads	14
Load Design Chart #6a - Roof/Floor Uniform Transverse Loads - Type S Spline	15
Load Design Chart #6b - Roof/Floor Uniform Transverse Loads - Type I Spline	16
Load Design Chart #6c - Roof/Floor Uniform Transverse Loads - Type L Spine	17
Load Design Chart #7a - Roof/Floor Diaphragms Loads - Type S Spline	18
Premier Screw Length Guide	19
Premier Wood Screws	20
Premier Light Duty Metal Screws	21
Premier Heavy Duty Metal Screws	22
Nail and Screw Withdrawal Loads - 7/16 in. OSB	23
Nail and Screw Withdrawal Loads - 5/8 in. OSB	24
Nail and Screw Withdrawal Loads - 3/4 in. OSB	25

Premier SIP Structural Review

Architect/Engineering Review

The Load Design Charts for Premier SIPS have been developed from national testing standards, testing at independent laboratories, and qualified structural engineers. These charts cover most common construction requirements. Each building project should be reviewed by an architect/engineer to determine the suitability of Premier SIPS. Extrapolating design capacities for conditions outside the scope of the load charts is not recommended.

Building Codes

Premier SIPS are recognized as being in compliance with the 2015 and 2018 International Building Code and 2015 and 2018 International Residential Code. Premier SIPS should be designed to comply with the deflection limits of the applicable building code.

Evaluation Reports

The International Code Council Evaluation Service (ICC-ES) has reviewed the independent testing, structural engineering, third party inspections, and QC program for Premier SIPS and has issued Evaluation Report ESR-4524, Listing Report ESL-1207, and Listing Report ESL-1208.



Premier SIP R-values

SIP R-values						
SIP Thickness	R-value at 75° F		R-value at 40° F		R-value at 25° F	
	EPS Core	GPS Core	EPS Core	GPS Core	EPS Core	GPS Core
4-1/2"	15	18	16	19	17	20
6-1/2"	23	28	25	29	26	30
8-1/4"	30	36	32	38	33	40
10-1/4"	37	45	40	48	42	50
12-1/4"	45	55	49	58	51	60

Premier SIP Weight

SIP Weight	
SIP Thickness	Weight (psf)
4-1/2"	3.3
6-1/2"	3.5
8-1/4"	3.7
10-1/4"	3.9
12-1/4"	4.0

Premier SIPs can be provided with custom 5/8 in. or 3/4 in. OSB facings. Add 1.3 psf to above SIP weight for 5/8 in. OSB facings. Add 2.2 psf to above SIP weight for 3/4 in. OSB facings.

Splines

Premier SIPS are connected by splines. There are three types of spline connections, listed below. Splines vary based on their intended purpose. If splines are simply acting as a connection between panels, the “Type S” spline meets this requirement while eliminating thermal bridging. If the purpose of the spline is also to provide additional structural support, “Type I” or “Type L” splines can be used. Determination of proper spline for the application can be determined by the use of Premier’s Load Design Charts on the following pages.

Type S

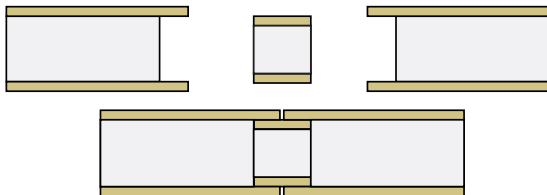

Type L

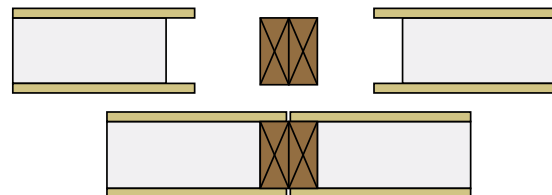

Type I

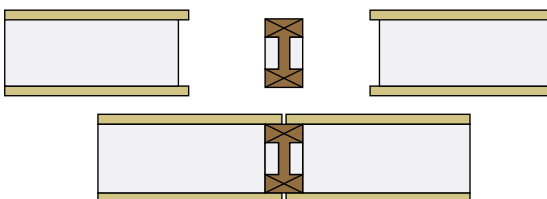

Load Design Chart #1a provides maximum allowable uniformly distributed pounds per lineal foot (PLF) axial load based on SIP thickness and height with Type S spline. Joists or trusses spaced 24 in. o.c. or closer are considered uniform loads. See Load Design Chart 2a for point loads.

Load Design Chart #1a

Uniform Axial Loads - PLF ¹⁻⁴						
LOAD DESIGN CHART #1a						
TYPE S SPLINE						
SIP Thickness	SIP Height (ft.)					
	8	10	12	16	20	24
4-1/2"	3500	2553	2453	2117	NA	NA
6-1/2"	4250	4043	3373	3923	2817	2183
8-1/4"	4917	4327	4473	4197	3497	3067
10-1/4"	4600	4414	4228	4417	3389	3248
12-1/4"	3889	3959	4028	4408	3837	3333

¹ Permanent loads, such as dead load, shall not exceed 0.50 times the tabulated load.

² Uniform axial loads.

³ Both facings must bear on the supporting foundation or structure.

⁴ Tabulated values for 8-foot (2.44 m) walls apply to SIPs constructed with OSB strength axis oriented either parallel or perpendicular to supports.

Axial

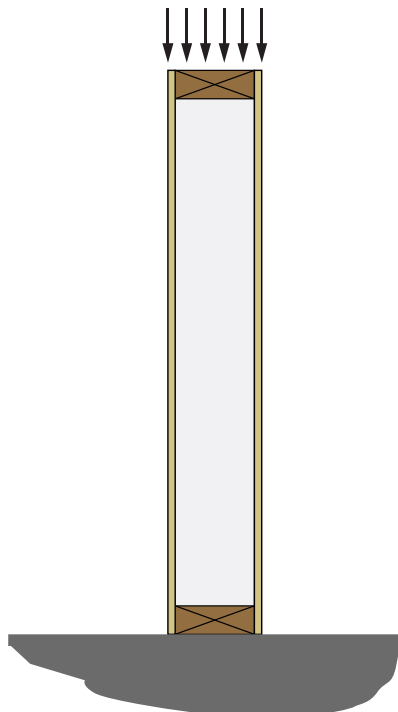

Type S

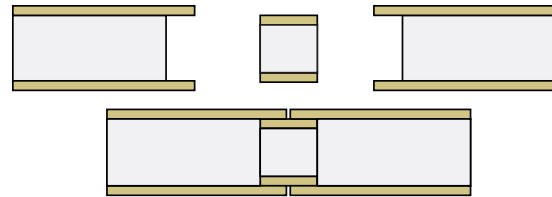

Load Design Chart #1b provides maximum allowable uniformly distributed pounds per lineal foot (PLF) axial load based on SIP thickness and height with Type L spline. Joists or trusses spaced 24 in. o.c. or closer are considered uniform loads. Use Type L spline for point loads.

Load Design Chart #1b

Uniform Axial Loads - PLF ¹⁻⁴						
LOAD DESIGN CHART #1b						
TYPE L SPLINE						
SIP Thickness	SIP Height (ft.)					
	8	10	12	16	20	24
4-1/2"	4723	3903	3273	2623	NA	NA
6-1/2"	5850	5890	4277	4310	2933	2837
8-1/4"	6807	6110	5557	5180	4837	4083
10-1/4"	5473	5709	5946	5948	4729	4250
12-1/4"	5667	5474	5281	5775	4729	4223

¹ Splines consist of No. 2 or better, Hem-Fir, 1-1/2 inch (38.1 mm) wide with depth equal to the core thickness, spaced to provide no less than two members for every 48 inches (1219.2 mm) of SIPs width. Permanent loads, such as dead load, shall not exceed 0.50 times the tabulated load.

² Uniform axial loads.

³ Both facings must bear on the supporting foundation or structure.

⁴ Tabulated values for 8-foot (2.44 m) walls apply to SIPs constructed with OSB strength axis oriented either parallel or perpendicular to supports.

Axial

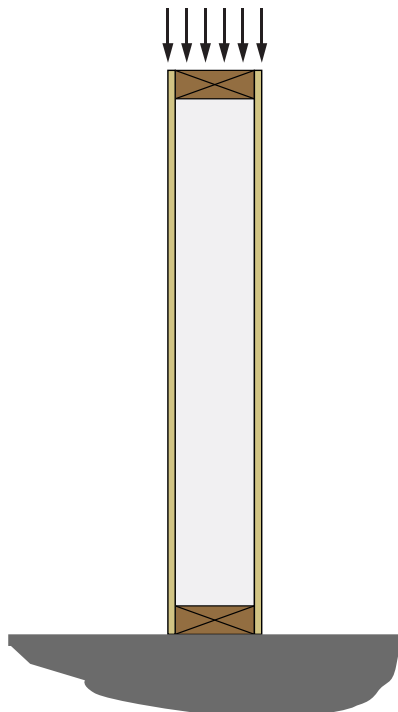

Type L

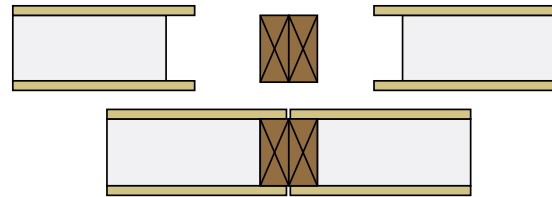

Load Design Chart #2a provides maximum allowable point load in pounds based on SIP Top Plate and/or Cap Plate. Loads exceeding those allowed require additional framing members.

Load Design Chart #2a

Axial Point Loads - LBS ¹⁻²		
LOAD DESIGN CHART #2a		
TYPE S SPLINE		
Top Plate Configuration	1-1/2" BEARING WIDTH	3" BEARING WIDTH
Single 2x4 No. 2 or better Hem-Fir Plate	2040	2450
Single 2x4 No. 2 or better Hem-Fir Plate with 1-1/8 in. thick 1.3E Rim Board Cap Plate	4030	4678

¹ Permanent loads, such as dead load, shall not exceed 0.50 times the tabulated load.

² Tabulated values are based on the strong-axis of the facing material oriented parallel to the span direction.

Axial

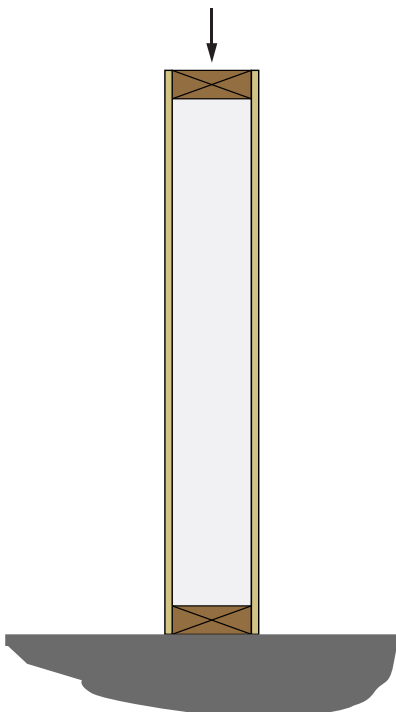

Top Plate

Cap Plate

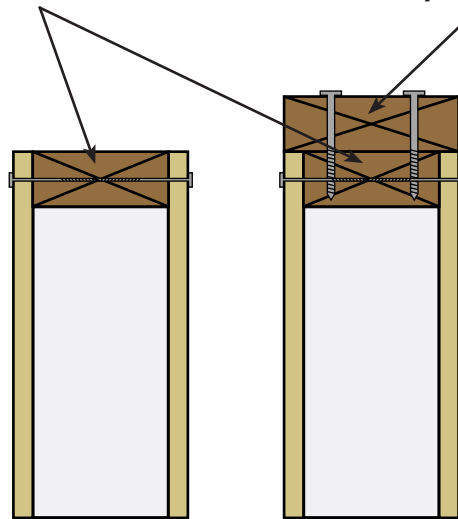

Type S

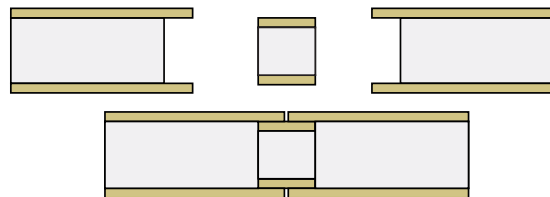

Load Design Chart #3a provides maximum allowable uniformly distributed pounds per square foot (PSF) wall transverse load based on SIP thickness and height with Type S Splines.

Load Design Chart #3a

Wall Uniform Transverse Loads - PSF ¹⁻³										
LOAD DESIGN CHART #3a										
TYPE S SPLINE										
SIP Thickness	Deflection Limit	SIP Height (feet)								
		8	10	12	14	16	18	20	22	24
4-1/2"	L/360	32	23	18	14	11	NA	NA	NA	NA
	L/240	48	35	27	21	16	NA	NA	NA	NA
	L/180	55	44	36	28	22	NA	NA	NA	NA
6-1/2"	L/360	51	38	29	23	19	15	12	NA	NA
	L/240	67	53	44	35	28	23	19	NA	NA
	L/180	67	53	44	38	33	29	24	NA	NA
8-1/4"	L/360	67	51	40	32	26	22	18	15	13
	L/240	75	60	50	42	37	33	27	23	19
	L/180	75	60	50	42	37	33	30	26	22
10-1/4"	L/360	83	66	52	43	35	29	25	21	18
	L/240	83	66	55	47	41	36	33	30	27
	L/180	83	66	55	47	41	36	33	30	27
12-1/4"	L/360	89	72	60	51	44	37	32	27	23
	L/240	89	72	60	51	45	40	36	32	30
	L/180	89	72	60	51	45	40	36	32	30

¹ Permanent loads, such as dead load, shall not exceed 0.50 times the tabulated load.

² Deflection limit shall be selected by building designer based on the serviceability requirements of the structure and the requirements of applicable building code. Values are based on loads of short duration only.

³ Table values for 8-foot (2.44 m) spans apply to SIPs constructed with the OSB strength axis oriented either parallel or perpendicular to span direction. Table values for other spans are based on the OSB strength axis parallel to the span direction..

Transverse

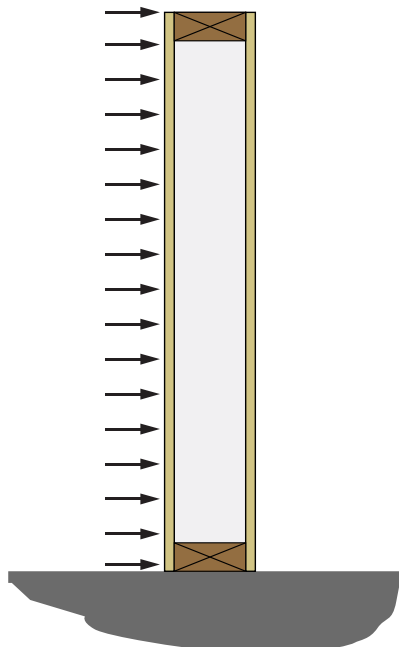

Type S

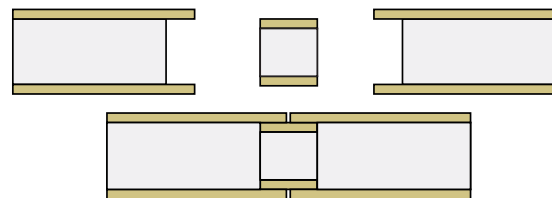

Load Design Chart #3b provides maximum allowable uniformly distributed pounds per square foot (PSF) curtain wall transverse load based on SIP thickness and height with Type S Splines. SIPs installed in curtain wall application over support members.

Load Design Chart #3b

Curtain Wall Uniform Transverse Loads - PSF ¹⁻³											
LOAD DESIGN CHART #3b											
TYPE S SPLINE											
SIP Thickness	Deflection Limit	SIP Height (feet)									
		4 ⁴	8	10	12	14	16	18	20	22	24
4-1/2"	L/360	100	32	23	18	14	11	NA	NA	NA	NA
	L/240	143	48	35	27	21	16	NA	NA	NA	NA
	L/180	143	63	47	36	28	22	NA	NA	NA	NA
6-1/2"	L/360	105	51	38	29	23	19	15	12	NA	NA
	L/240	162	76	57	44	35	28	23	19	NA	NA
	L/180	191	80	61	50	42	36	30	24	NA	NA
8-1/4"	L/360	120	67	51	40	32	26	22	18	15	13
	L/240	179	94	71	57	48	40	33	27	23	19
	L/180	179	94	71	57	48	41	36	32	26	22
10-1/4"	L/360	131	86	66	52	43	35	29	25	21	18
	L/240	168	94	75	63	54	47	41	36	32	27
	L/180	168	94	75	63	54	47	41	36	33	28
12-1/4"	L/360	132	94	75	63	53	44	37	32	27	23
	L/240	163	94	75	63	54	47	42	37	34	31
	L/180	163	94	75	63	54	47	42	37	34	31

¹ Table values assume a simply supported SIP with 1-1/2 inches (38.1 mm) of continuous bearing. Permanent loads, such as dead load, shall not exceed 0.50 times the tabulated load. Values do not include the dead weight of the SIP.

² Deflection limit shall be selected by building designer based on the serviceability requirements of the structure and the requirements of applicable building code. Values are based on loads of short duration only and do not consider the effects of creep.

³ Table values for 8-foot (2.44 m) spans apply to SIPs constructed with the OSB strength axis oriented either parallel or perpendicular to span direction. Table values for other spans are based on the OSB strength axis parallel to the span direction.

⁴ SIPs shall be a minimum of 8-foot (2.44 m) long spanning two 4-foot (1.22 m) spans.

Transverse

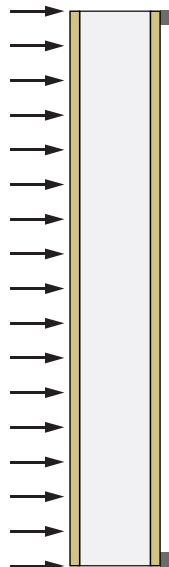

Type S

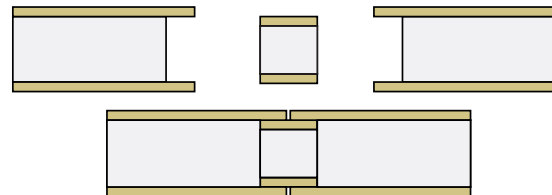

Load Design Chart #4a provides maximum allowable uniformly distributed pounds per lineal foot (PLF) shear load based on fastening pattern with Type S or Type L splines. Seismic Design Categories A-C.

Load Design Chart #4a

Shear Loads - PLF ¹⁻⁷ Seismic Design Categories A-C				
LOAD DESIGN CHART #4a				
TYPE S or TYPE L SPLINE				
Framing Minimum SG	Minimum Facing Connections ⁴			Shear Load (PLF)
	Chord ^{4,5}	Plate	Spline	
0.50	0.113"x 2-1/2" nails 6" on center	0.113"x 2-1/2" nails 6" on center	0.113"x 2-1/2" nails 6" on center	410
0.50	0.113"x 2-3/8" nails 6" on center Staggered (2 rows)	0.113"x 2-3/8" nails 6" on center	0.113"x 2-3/8" nails 6" on center ⁶	460
0.42	0.113"x 2-3/8" nails 6" on center Staggered (2 rows)	0.113"x 2-3/8" nails 4" on center Staggered (2 rows)	0.113"x 2-3/8" nails 4" on center ⁶	700
0.42	0.148"x 2-3/8" nails 6" on center Staggered (2 rows)	0.148"x 2-2/8" nails 3" on center	0.148"x 2-3/8" nails 3" on center Staggered (2 rows) ⁷	1000

¹ Wind and seismic loads in seismic design categories A, B, C.

² Aspect ratio (height:width) does not exceed 2:1.

³ Shear wall height-width ratios greater than 2:1, but not exceeding 3.5:1, are permitted for assemblies using lumber splines provided the allowable shear strength values in the table are multiplied by 2w/h.

⁴ Required connections must be made on each side of the SIPs. Dimensional or engineered lumber shall have an equivalent specific gravity not less than specified.

⁵ Chords, hold-downs and connections to other structural elements must be designed by a registered designer professional in accordance with accepted engineering practice.

⁶ 4 inch (101.6 mm) wide spline.

⁷ 4 inch (101.6 mm), 23/32 inch (18.25 mm) thick facing.

Shear

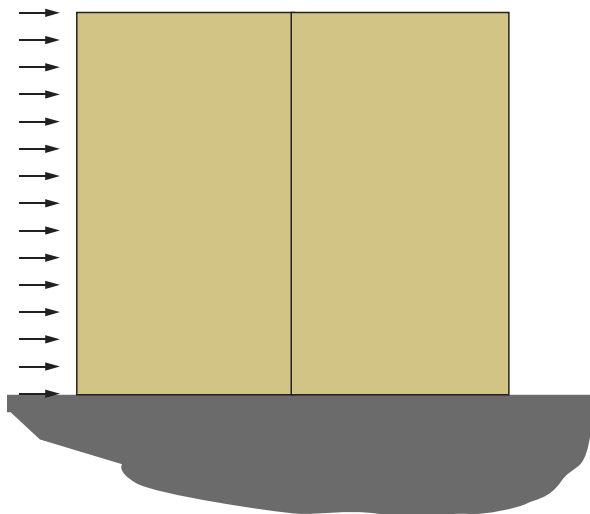

Type S

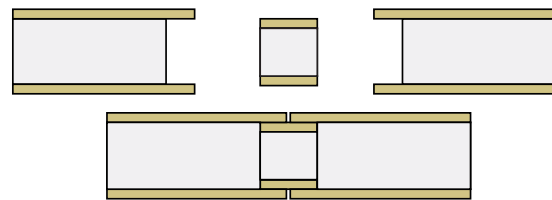

Type L

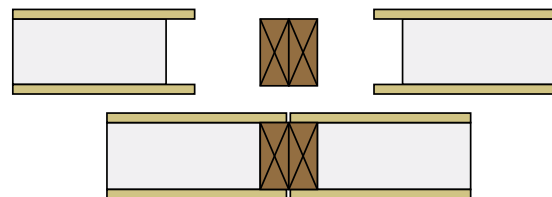

Load Design Chart #4b provides maximum allowable uniformly distributed pounds per lineal foot (PLF) shear load based on fastening pattern with Type S or Type L splines. Seismic Design Categories A-F.

Load Design Chart #4b

Shear Loads - PLF ¹⁻⁷ Seismic Design Categories A-F				
LOAD DESIGN CHART #4b				
TYPE S or TYPE L SPLINE				
Framing Minimum SG ⁴	Minimum Facing Connections ⁴			Shear Load ^{2,3} (PLF)
	Chord ⁵	Plate	Spline ⁴	
0.50	0.113"x 2-1/4" nails 6" on center	0.113"x 2-1/4" nails 3" on center	0.113"x 2-1/4" nails 6" on center	360
0.50	0.113"x 2-1/4" nails 6" on center Staggered (2 rows)	0.113"x 2-1/4" nails 6" on center	0.113"x 2-1/4" nails 6" on center	360
0.50	0.113"x 2-3/8" nails 3" on center Staggered	0.113"x 2-3/8" nails 3" on center Staggered	0.113"x 2-3/8" nails 3" on center Staggered ⁷	720
0.50	0.113"x 2-3/8" nails 2" on center Staggered	0.113"x 2-3/8" nails 2" on center Staggered	0.113"x 2-3/8" nails 2" on center Staggered	920

¹ Seismic loads in seismic design categories A, B, C, D, E and F. Walls shall be designed using the seismic design coefficients and limitations provided in ASCE 7-10 for light-framed walls sheathing with wood structural panels rated for shear resistance. SIP walls shall use the following factors for design: Response Modification Coefficient, $R = 6.5$; System Overstrength Factor, $\Omega_0 = 3.0$; Deflection Amplification Factor, $C_d = 4.0$.

² Aspect ratio (height:width) does not exceed 1:1 for Type S spline or 2:1 for Type L spline.

³ Shear wall height-width ratios greater the 2:1, but not exceeding 3.5:1, are permitted for assemblies using lumber splines provided the allowable shear strength values in the table are multiplied by 2w/h.

⁴ Required connections must be made on each side of the SIP, Dimensional or engineered lumber shall have an equivalent specific gravity not less than specified in the table for the framing.

⁵ Chords, hold-downs and connections to other structural elements shall be reviewed and approved by a registered designer professional.

⁶ Solid chord members are required at each end of each shear wall segment. Dimensional double lumber splines must be interconnected using 10d common nails ([0.148-inch-diameter x 3 inches (3.8 mm x 76 mm)] spaced 5-inches (127 mm) on center.

⁷ 3 inch (76.2 mm) wide, 3/4 inch (19 mm) thick facing.

Shear

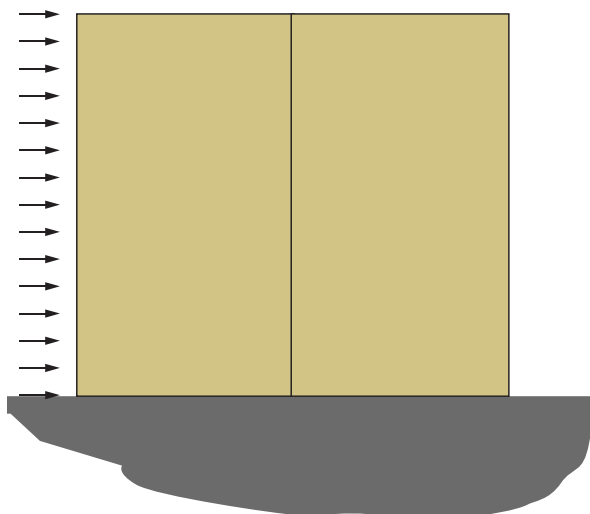

Type S

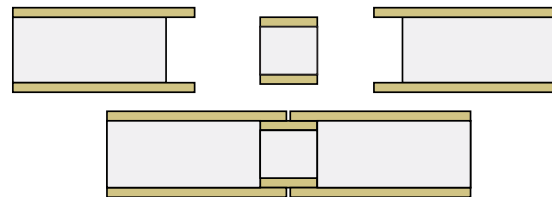

Type L

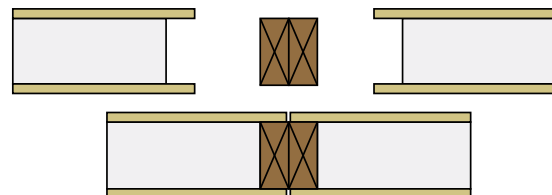

Load Design Chart #5a provides maximum allowable uniformly distributed pounds per lineal foot (PLF) header load for a SIP Header. Loads exceeding those allowed require alternative header.

Load Design Chart #5a

SIP Header Uniform Loads - PLF ¹⁻⁵						
LOAD DESIGN CHART #5a						
Header Depth ³ (inches)	Header Spline ⁵	Deflection Limit ⁴	Header Span (feet)			
			4	8	10	12
12	NO	L/480	740	384	228	142
		L/360	740	384	229	142
		L/240	740	384	229	142
	YES ⁵	L/480	345	243	156	99
		L/360	450	295	190	125
		L/240	630	382	236	153
18	NO	L/480	798	574	385	311
		L/360	798	574	385	311
		L/240	798	574	385	311
	YES ⁵	L/480	705	388	254	235
		L/360	750	482	302	281
		L/240	750	482	302	281
24	NO	L/480	886	629	429	361
		L/360	886	629	429	361
		L/240	886	629	429	361
	YES ⁵	L/480	698	556	368	350
		L/360	896	556	368	350
		L/240	896	556	368	350

¹ Vertical loads only. Lateral loads shall be transferred to the edges of the openings through continuous plate(s) designed in accordance with accepted engineering practice. Permanent loads, such as dead load, shall not exceed 0.50 times the tabulated load.

² Tabulated values are based on the strong-axis of the facing material oriented perpendicular to the direction of the header span.

³ Minimum depth of facing above opening.

⁴ Deflection limit shall be selected by building designer based on the serviceability requirements of the structure and requirements of applicable building code.

⁵ SIP header may contain a spline a minimum of 6 inches from edge of opening.

Header

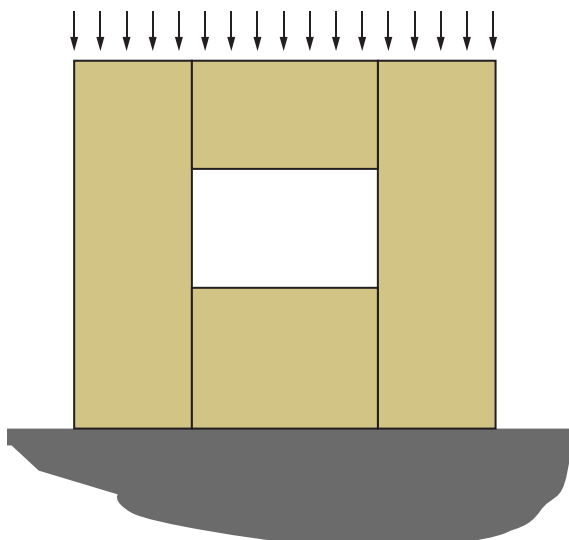

No Header Spline

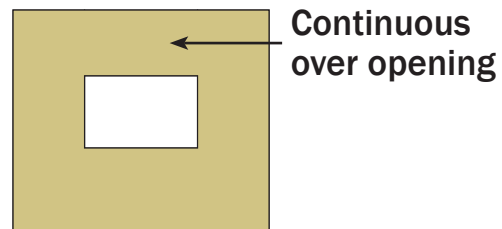

Header with Spline

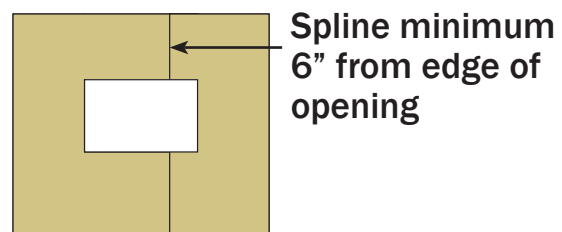

Load Design Chart #5b provides maximum allowable uniformly distributed pounds per lineal foot (PLF) header load for a Premier Insulated Header Beam. Loads exceeding those allowed require alternative header.

Load Design Chart #5b

Premier Insulated Header Beams Uniform Loads - PLF ¹									
LOAD DESIGN CHART #5b									
No. of Trimmer Studs	Deflection	Header Span (ft)							
		2'	3'	4'	5'	6'	7'	8'	
1	L/480	3150	2100	1575	1260	1050	900	788	
	L/360	3150	2100	1575	1260	1050	900	788	
	L/240	3150	2100	1575	1260	1050	900	788	
2	L/480	6300	4200	3150	2520	2100	1800	1545	
	L/360	6300	4200	3150	2520	2100	1800	1575	
	L/240	6300	4200	3150	2520	2100	1800	1575	
No. of Trimmer Studs	Deflection	Header Span (ft)							
		9'	10'	11'	12'	13'	14'	15'	16'
1	L/480	700	630	573	458	360	288	234	193
	L/360	700	630	573	525	480	384	313	257
	L/240	700	630	573	525	485	450	420	386
2	L/480	1085	791	594	458	360	288	234	193
	L/360	1400	1055	792	610	480	384	313	257
	L/240	1400	1245	792	864	720	577	469	386

¹ Values listed for each deflection represent the least value of the bearing capacity of the trimmer, shear or bearing capacity of the header or the actual deflection at the design load. Note: Trimmer stud design capacities must be reviewed.

Header

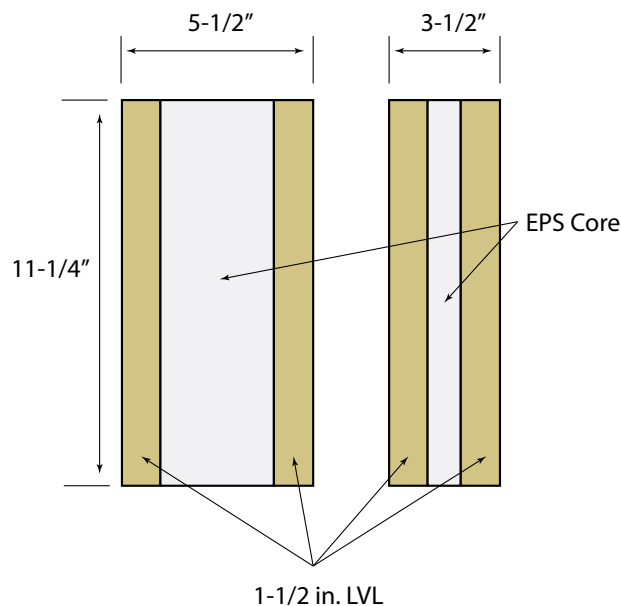

Load Design Chart #6a provides maximum allowable uniformly distributed pounds per square foot (PLF) roof/floor transverse load based on SIP thickness and span with Type S spline.

Load Design Chart #6a

Roof/Floor Uniform Transverse Loads - PSF ¹⁻⁴											
LOAD DESIGN CHART #6a											
TYPE S SPLINE											
SIP Thickness	Deflection Limit	SIP Span (feet)									
		4 ⁴	8	10	12	14	16	18	20	22	24
4-1/2"	L/360	100	32	23	NA	NA	NA	NA	NA	NA	NA
	L/240	143	48	35	NA	NA	NA	NA	NA	NA	NA
	L/180	143	63	47	NA	NA	NA	NA	NA	NA	NA
6-1/2"	L/360	105	51	38	29	23	NA	NA	NA	NA	NA
	L/240	162	76	57	44	35	NA	NA	NA	NA	NA
	L/180	191	80	61	50	42	NA	NA	NA	NA	NA
8-1/4"	L/360	120	67	51	40	32	26	22	NA	NA	NA
	L/240	179	94	71	57	48	40	33	NA	NA	NA
	L/180	179	94	71	57	48	41	36	NA	NA	NA
10-1/4"	L/360	131	86	66	52	43	35	29	25	21	NA
	L/240	168	94	75	63	54	47	41	36	32	NA
	L/180	168	94	75	63	54	47	41	36	33	NA
12-1/4"	L/360	132	94	75	63	53	44	37	32	27	23
	L/240	163	94	75	63	54	47	42	37	34	31
	L/180	163	94	75	63	54	47	42	37	34	31

¹ Table values assume a simply supported SIP with 1-1/2 inches (38.1 mm) of continuous bearing. Permanent loads, such as dead load, shall not exceed 0.50 times the tabulated load. Values do not include the dead weight of the SIP.

² Deflection limit shall be selected by building designer based on the serviceability requirements of the structure and the requirements of applicable building code. Values are based on loads of short duration only and do not consider the effects of creep.

³ Table values for 8-foot (2.44 m) spans apply to SIPs constructed with the OSB strength axis oriented either parallel or perpendicular to span direction. Table values for other spans are based on the OSB strength axis parallel to the span direction.

⁴ SIPs shall be a minimum of 8-foot (2.44 m) long spanning two 4-foot (1.22 m) spans.

Transverse

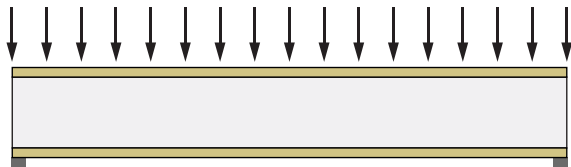

Type S

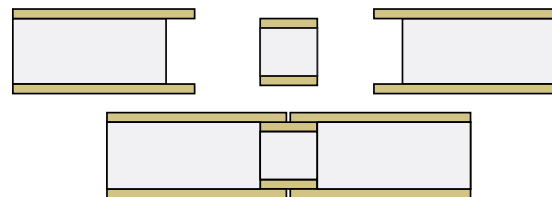

Load Design Chart #6b provides maximum allowable uniformly distributed pounds per square foot (PLF) roof/floor transverse load based on SIP thickness and span with Type I spline.



Load Design Chart #6b

Roof/Floor Uniform Transverse Loads - PSF ¹⁻⁴											
LOAD DESIGN CHART #6b											
TYPE I SPLINE											
SIP Thickness	Deflection Limit	SIP Span (feet)									
		4 ⁴	8	10	12	14	16	18	20	22	24
10-1/4"	L/360	197	164	124	72	67	61	48	34	29	24
	L/240	336	164	124	107	96	84	70	49	43	36
	L/180	336	164	124	107	96	84	76	65	56	47
12-1/4"	L/360	258	143	103	86	83	77	61	42	37	32
	L/240	318	143	103	93	85	77	68	59	54	46
	L/180	318	143	103	93	85	77	68	59	54	49

¹ Table values assume a simply supported SIP with 1-1/2 inches (38.1 mm) of continuous bearing. Permanent loads, such as dead load, shall not exceed 0.50 times the tabulated load. Splines consist of Premier I-beam, 2-1/4 inch (57.2 mm) wide flange (minimum) with a depth equal to the core thickness, spaced not to exceed 48 inches (1219.2 mm) on center.

² Deflection limit shall be selected by building designer based on the serviceability requirements of the structure and the requirements of applicable building code.

³ Tabulated values for 8-foot (2.44 m) walls apply to SIPs constructed with the OSB strength axis oriented either parallel or perpendicular to supports. Tabulated values for other lengths are based on the strong-axis of the facing material oriented either parallel to the span direction.

⁴ SIP shall be a minimum of 8 foot (2.44 m) long spanning a minimum of two 4-foot (1.22 m) spans.

Transverse

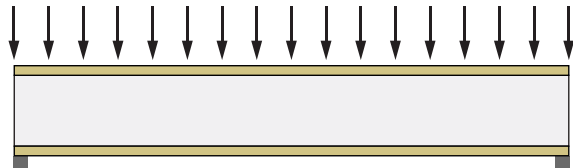

Type I

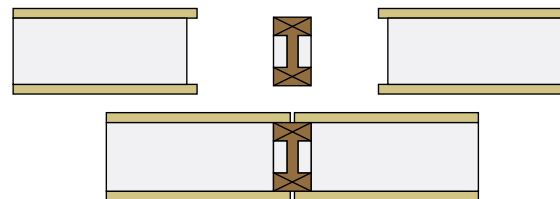

Load Design Chart #6c provides maximum allowable uniformly distributed pounds per square foot (PLF) roof/floor transverse load based on SIP thickness and span with Type L spline.

Load Design Chart #6c

Roof/Floor Uniform Transverse Loads - PSF ¹⁻⁴											
LOAD DESIGN CHART #6c											
TYPE L SPLINE											
SIP Thickness	Deflection Limit	SIP Span (feet)									
		4 ⁴	8	10	12	14	16	18	20	22	24
4-1/2"	L/360	103	45	33	24	NA	NA	NA	NA	NA	NA
	L/240	225	68	47	34	NA	NA	NA	NA	NA	NA
	L/180	297	91	61	45	NA	NA	NA	NA	NA	NA
6-1/2"	L/360	307	129	57	42	34	25	20	NA	NA	NA
	L/240	307	182	87	61	49	37	30	NA	NA	NA
	L/180	307	182	112	80	65	49	39	NA	NA	NA
8-1/4"	L/360	253	171	82	66	54	41	32	23	NA	NA
	L/240	288	188	128	100	81	61	48	35	NA	NA
	L/180	288	188	133	117	105	80	63	45	NA	NA
10-1/4"	L/360	286	188	117	101	80	58	47	36	32	27
	L/240	326	188	147	134	120	90	71	52	47	41
	L/180	326	188	147	134	121	106	93	68	61	53
12-1/4"	L/360	327	188	167	141	116	91	75	58	47	36
	L/240	327	188	167	153	132	110	97	83	69	53
	L/180	327	188	167	153	132	110	97	83	83	70

¹ Table values assume a simply supported SIP with 1-1/2 inches (38.1 mm) of continuous bearing. Permanent loads, such as dead load, shall not exceed 0.50 times the tabulated load. Splines consist of No. 2 or better Hem-Fir, 1-1/2 inches (38.1 mm) wide with a depth equal to the core thickness, spaced to provide not less than two members for every 48 inches (1219.2 mm) of SIP width.

² Deflection limit shall be selected by building designer based on the serviceability requirements of the structure and the requirements of applicable building code.

³ Tabulated values for 8-foot (2.44 m) walls apply to SIPs constructed with the OSB strength axis oriented either parallel or perpendicular to supports. Tabulated values for other lengths are based on strong-axis of the facing material oriented parallel to the span direction.

⁴ SIP shall be a minimum of 8 foot (2.44 m) long spanning two 4-foot (1.22 m) spans. No single span condition is allowed.

Transverse

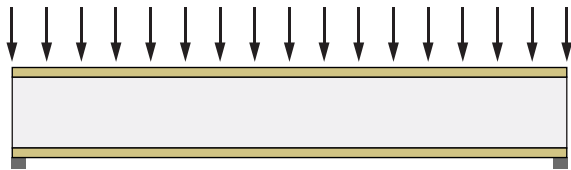

Type L

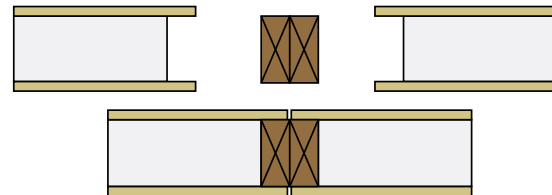

Load Design Chart #7a provides maximum allowable uniformly distributed pounds per square foot (PLF) diaphragm load based on fastening pattern with Type S spline.

Load Design Chart #7a

Roof/Floor Diaphragms Loads - PLF ¹⁻⁶						
LOAD DESIGN CHART #7a						
TYPE S SPLINE						
Minimum Connections ²				Allowable Shear Load (PLF)	G' Apparent Shear Stiffness (lbf/in)	Maximum Aspect Ratio
Interior Supports ²	Spline ³	Boundary ⁴				
		Support	Spline			
SIP Screw 12" on center ⁵	0.113"x 2-1/2" nails 3" on center	SIP Screw 12" on center ⁵	0.113"x 2-1/2" nails, 6" on center	430	24000	4:1
SIP Screw 12" on center ⁵	0.113"x 2-1/2" nails 3" on center 2 rows, Staggered	SIP Screw 3" on center ⁵	0.113"x 2-1/2" nails, 4" on center	530	30300	4:1
SIP Screw 2" on center ⁵	0.113"x 2-1/2" nails 3" on center 2 rows, Staggered	SIP Screw 2" on center ⁵	0.113"x 2-1/2" nails, 1-1/2" on center	750	41300	4:1
SIP Screw 4" on center ⁵	0.113"x 2-1/2" nails 3" on center 2 rows, Staggered	SIP Screw 4" on center ⁵	0.113"x 2-1/2" nails, 3" on center	915	93700	3:1
SIP Screw 4" on center ⁵	0.113"x 2-1/2" nails 6" on center 2 rows, Staggered ⁶	SIP Screw 4" on center ⁵	0.113"x 2-1/2" nails, 6" on center	1130	110600	3:1

- ¹ The maximum diaphragm length-to-width ratio shall not exceed 4:1. Load may be applied parallel to continuous SIP joints.
- ² Interior supports shall be spaced not to exceed 12 feet (3.66 m) on center and have a minimum width of 3-1/2 inches (88.9 mm) and a specific gravity of 0.42 or greater. Specified fasteners are required on both side of the SIP joint where SIPs are joined over a support.
- ³ Top splines only, at interior SIP-to-SIP joints. Specified fasteners are required on both sides of the SIP joint.
- ⁴ Boundary spline shall be solid 1-1/2 inches (38.1 mm) wide, minimum, and have a specific gravity of 0.42 or greater. Boundary supports shall have a minimum width of 3-1/2 inches (88.9 mm) and a specific gravity of 0.42 or greater. Specified spline fasteners are required through both facings.
- ⁵ 1 inch (25.4 mm) penetration.
- ⁶ 4 inch (101.6 mm) 23/32 in (18.25 mm) thick facing.

Diaphragm

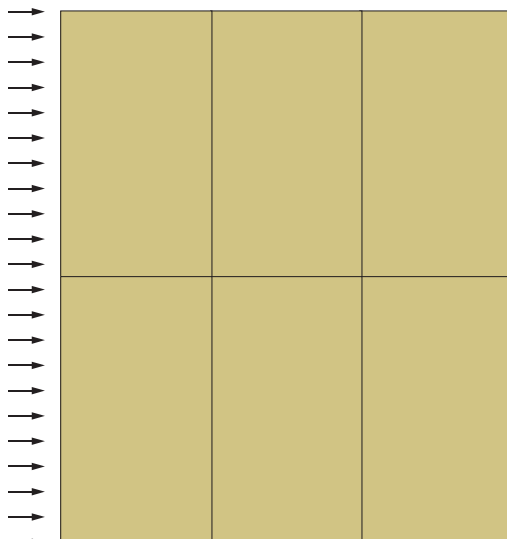

Type S

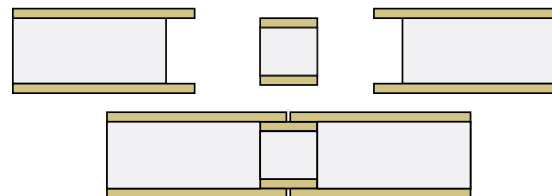

Premier Screw Length Guide provides recommended Premier SIP Screw length required based on SIP thickness and roof slope.



Premier Screw Length Guide

SIP Thickness ¹					
Slope	4-1/2"	6-1/2"	8-1/4"	10-1/4"	12-1/4"
2/12	6"	8"	10"	12"	14"
4/12	6"	8"	10"	12"	14"
6/12	7"	9"	10"	12"	14"
8/12	7"	9"	11"	13"	15"
10/12	8"	10"	12"	14"	16"
12/12	8"	10"	12"	14"	16"

¹ Provides roughly a 1" penetration into the top plate.

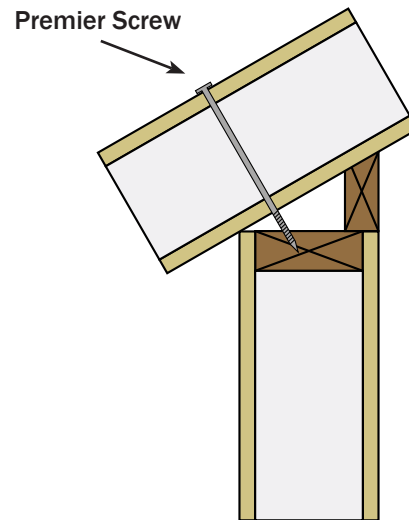

Premier Wood Screw properties are provided. All values are average ultimate values. As determined by the project architect/engineer, appropriate safety factors must be used in design.

Premier Wood Screws

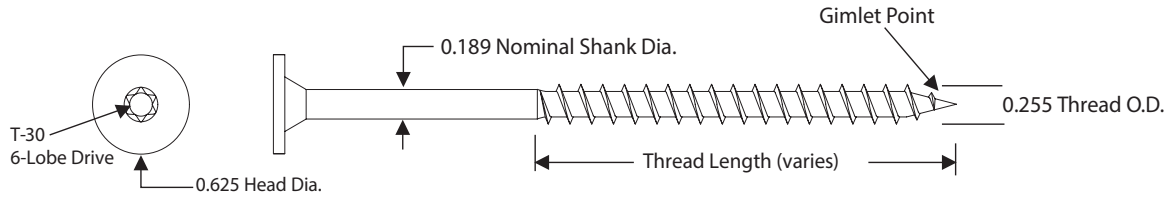

Wood Screw Properties			
Tensile (lbs) AISI S904	Shear (lbs) AISI S904	Bending Yield Strength - Fyb (psi) ASTM F1575	Corrosive Resistance ASTM D6294, ETAG 006
3555	2580	185,000	<15% Red Rust after 30 cycles

Withdrawal: Lumber & Engineered Wood - lbs/in. ¹							
SPF/HF (0.42)		DF/SP (0.50)		LVL (0.50)		LSL (0.50)	OSB (7/16")
Face Grain	Edge Grain	Face Grain	Edge Grain	Face Grain	Edge Grain	Face Grain	Face
799	615	899	702	556	495	711	265

¹ Load values include fastener tip.

Withdrawal: Concrete & CMU - lbs ¹		
2500 psi Concrete	5000 psi Concrete	CMU ²
682	869	713

¹ Fastener penetrates 1" into concrete or CMU clock, including the tip.

² Concrete Masonary unit (CMU) conforming to ASTM C90.

Head Pull-Thru - lbs	
7/16" OSB	SIP
490	630

Lateral Load Resistance - lbs		
Main Member	Side Member	Load
SPF ¹	8-1/4" SIP	943

¹ 1-3/4" fastener embedment into edge grain, including tip.

Premier Light Duty Metal Screw properties are provided. All values are average ultimate values. As determined by the project architect/engineer, appropriate safety factors must be used in design.



Premier Light Duty Metal Screws

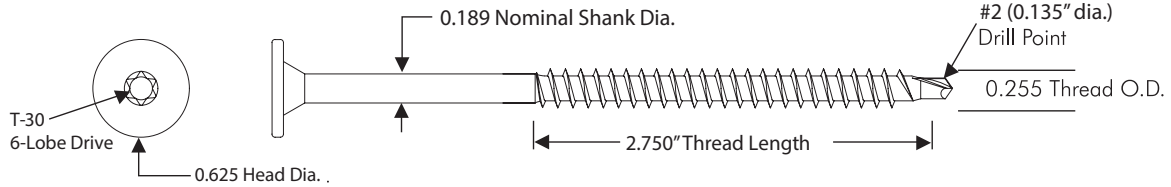

Light Duty Metal Screw Properties			
Tensile (lbs) AISI S904	Shear (lbs) AISI S904	Bending Yield Strength - Fyb (psi) ASTM F1575	Corrosive Resistance ASTM D6294, ETAG 006
3390	2490	185,000	<15% Red Rust after 30 cycles

Withdrawal: Corrugated Steel Deck - lbs						
24 ga. (36 ksi)	22 ga. (36 ksi)	22 ga. (85 ksi)	20 ga. (36 ksi)	18 ga. (36 ksi)	16 ga. (36 ksi)	16 ga. (100 ksi)
250	381	435	449	694	896	1186

* Minimum 3/4" penetration of fastener through deck from underside of deck.

Withdrawal: Lumber & Engineered Wood - lbs/in. ¹							
SPF/HF (0.42)		DF/SP (0.50)		LVL (0.50)		LSL (0.50)	OSB (7/16")
Face Grain	Edge Grain	Face Grain	Edge Grain	Face Grain	Edge Grain	Face Grain	Face
662	497	732	720	540	469	646	284

¹ Load values include fastener tip.

Head Pull-Through - lbs	
7/16" OSB	SIP
490	630

Premier Heavy Duty Metal Screw properties are provided. All values are average ultimate values. As determined by the project architect/engineer, appropriate safety factors must be used in design.



Premier Heavy Duty Metal Screws

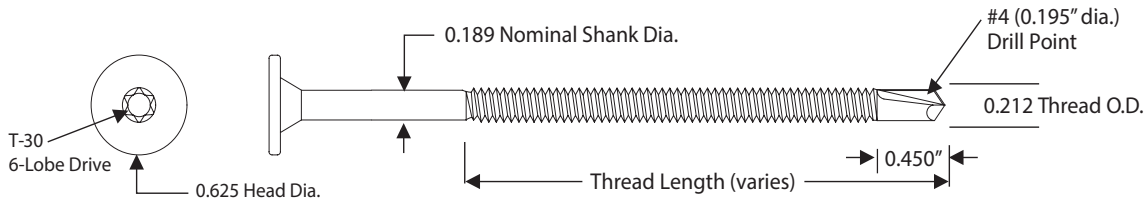

Heavy Duty Metal Screw Properties			
Tensile (lbs) AISI S904	Shear (lbs) AISI S904	Bending Yield Strength - Fyb (psi) ASTM F1575	Corrosive Resistance ASTM D6294, ETAG 006
3855	2625	185,000	<15% Red Rust after 30 cycles

Withdrawal: Corrugated Steel Deck - lbs ¹					
16 ga. (36 ksi)	16 ga. (100 ksi)	12 ga. (50 ksi)	1/8" (36 ksi)	3/16" (60 ksi)	1/4" (60 ksi)
491	794	1255	1454	3098	3814

¹ Minimum (3) threads of penetration of fastener through deck as measured from underside of steel.

Head Pull-Thru - lbs	
7/16" OSB	SIP
490	630

Lateral Load Resistance - lbs		
Main Member	Side Member	Load
1/8" Structural Steel ¹	8-1/4" SIP	929

¹ Minimum (3) threads of penetration of fastener through steel as measured from underside of steel.

Nail and Screw withdrawal design loads when installed in the 7/16 in. OSB facing of a Premier SIP.



Nail and Screw Withdrawal Loads - 7/16 in OSB

Fasteners shall be long enough to penetrate OSB by at least 1/4 in. Please refer to APA Technical Topics TT-109 for complete details.

Wood Screws Withdrawal Loads							
Gauge	#6	#7	#8	#9	#10	#12	#14
Diameter (in.)	0.138	0.151	0.164	0.177	0.190	0.216	0.242
lbs	56	61	66	72	77	87	98

Rink Shank Nail Withdrawal Loads								
Diameter (in.)	0.091	0.094	0.097	0.113	0.120	0.128	0.135	0.148
lbs	36	37	38	45	48	51	53	59

Smooth Shank Nail Withdrawal Loads								
Diameter (in.)	0.092	0.099	0.113	0.120	0.128	0.131	0.135	0.148
lbs	9	10	11	12	13	13	13	14

Nail and Screw withdrawal design loads when installed in the 5/8 in. OSB facing of a Premier SIP.



Nail and Screw Withdrawal Loads - 5/8 in. OSB

Fasteners shall be long enough to penetrate OSB by at least 1/4 in. Please refer to APA Technical Topics TT-109 for complete details.

Wood Screws Withdrawal Loads							
Gauge	#6	#7	#8	#9	#10	#12	#14
Diameter (in.)	0.138	0.151	0.164	0.177	0.190	0.216	0.242
lbs	75	83	90	97	104	118	133

Rink Shank Nail Withdrawal Loads								
Diameter (in.)	0.091	0.094	0.097	0.113	0.120	0.128	0.135	0.148
lbs	49	51	52	61	64	69	73	80

Smooth Shank Nail Withdrawal Loads								
Diameter (in.)	0.092	0.099	0.113	0.120	0.128	0.131	0.135	0.148
lbs	12	13	15	16	17	17	18	20

Nail and Screw withdrawal design loads when installed in the 3/4 in. OSB facing of a Premier SIP.



Nail and Screw Withdrawal Loads - 3/4 in. OSB

Fasteners shall be long enough to penetrate OSB by at least 1/4 in. Please refer to APA Technical Topics TT-109 for complete details.

Wood Screws Withdrawal Loads							
Gauge	#6	#7	#8	#9	#10	#12	#14
Diameter (in.)	0.138	0.151	0.164	0.177	0.190	0.216	0.242
lbs	92	100	109	117	126	143	161

Rink Shank Nail Withdrawal Loads								
Diameter (in.)	0.091	0.094	0.097	0.113	0.120	0.128	0.135	0.148
lbs	59	61	63	74	78	83	88	96

Smooth Shank Nail Withdrawal Loads								
Diameter (in.)	0.092	0.099	0.113	0.120	0.128	0.131	0.135	0.148
lbs	15	16	18	19	21	21	22	24



Premier Building Systems, LLC.
18504 Canyon Rd. E.
Puyallup, WA 98375

Toll Free: 800.275.7086
Email: info@premiersips.com
Website: www.premiersips.com



PREMIER
BUILDING SYSTEMS